

Article number: 12713000100120

Description: KLEE-coil 713 000 100.120  
M10 Unhardened, zinc-pl. & chr. yellow

## Measures

---

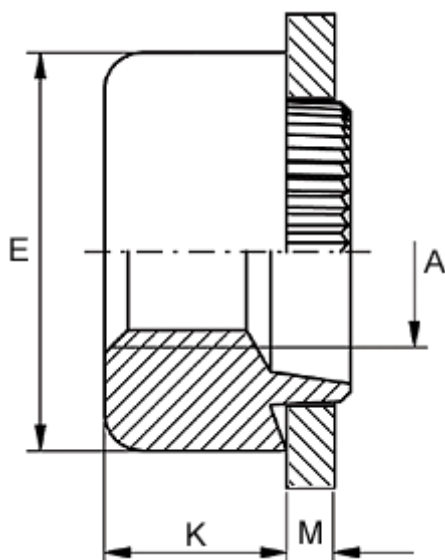

|  |              |
|--|--------------|
| Female thread A                            | = M10        |
| Height K                                   | = 8.0        |
| Outer diameter E                           | = 19.0       |
| Plate thickness                            | = 3.5 to 3.7 |
| Recommended bore diameter for extreme load | = 15.0       |
| Recommended bore diameter for normal use   | = 16.0       |